

# STORAGE SYSTEM

—  
FOR DEFENSE AND SECURITY  
(WEAPONS STORAGE)



# TABLE OF CONTENTS

|  |           |
|--|-----------|
| <b>TABLE OF CONTENTS</b>   | <b>2</b>  |
| <b>INTRODUCTION TO WEAPONS STORAGE</b>                               | <b>3</b>  |
| <b>R CABINET</b>   | <b>4</b>  |
| <b>3-STEP CONFIGURATION</b>  | <b>4</b>  |
| <b>1 WEAPON TYPE</b>   | <b>4</b>  |
| Machine Guns .....   | 4         |
| Assault Rifles and Shotguns .....                                    | 5         |
| Light Machine Guns .....   | 5         |
| Precision Rifles/ Marksman Rifles .....                              | 6         |
| Pistols.....   | 6         |
| Rocket Launchers, Grenade Launchers,<br>Heavy Machine Guns, etc..... | 7         |
| Light and Medium Mortars .....                                       | 7         |
| <b>1 BOLT TYPE</b>   | <b>8</b>  |
| Bolt for Machine guns .....  | 8         |
| Bolt for Assault Rifles.....   | 9         |
| Bolt for Light Machine Guns .....                                    | 10        |
| Pistol Slides.....   | 11        |
| <b>2 HOUSING</b>   | <b>12</b> |
| <b>3 CABINET ACCESSORIES</b>   | <b>13</b> |
| Cabinet Tops.....  | 13        |
| Cabinet Bases.....   | 14        |
| Casters.....   | 15        |
| <b>R2V VERTICAL STORAGE</b>  | <b>16</b> |
| <b>1 WEAPON TYPE</b>   | <b>16</b> |
| Rifles and Shotguns.....   | 16        |
| <b>2 R2V VERTICAL HOUSING</b>  | <b>17</b> |
| <b>3 R2V ACCESSOIRES</b>   | <b>20</b> |
| Supports and hooks .....   | 20        |
| Drawers interiors.....   | 21        |

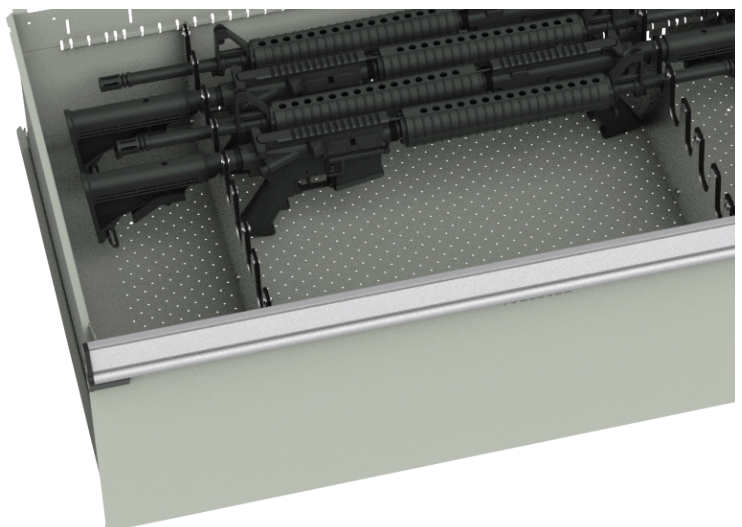

# INTRODUCTION TO WEAPONS STORAGE

This brochure illustrates various solutions for storing common weapons in Rousseau drawers.

It remains the client's responsibility to ensure that storage complies with applicable safety standards for its intended use, as well as to validate dimensional compatibility between the weapons and our storage solutions.

## We recommend carefully verifying:

- The dimensions of the cutouts,
- The usable space inside the drawers,
- And any other relevant specifications.

**NOTES:** The dimensions shown are the only dimensions available.

Compatible with most of the mentioned weapon types and other ones, refer to the dimensions indicated in the tables.

## UNIQUE FEATURES FOR WEAPONS STORAGE

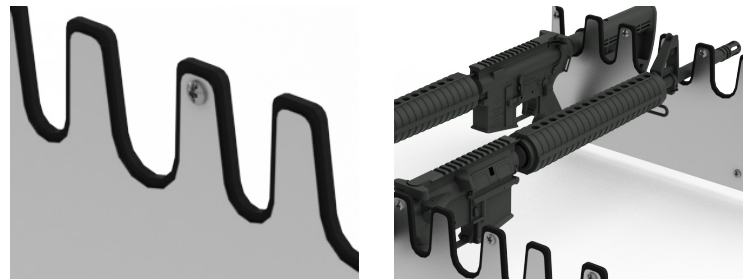

CLOSED

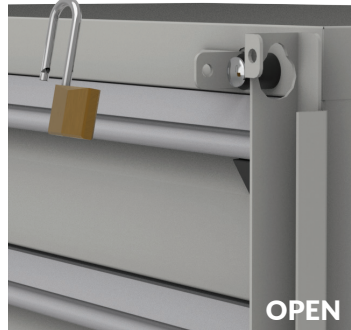

OPEN

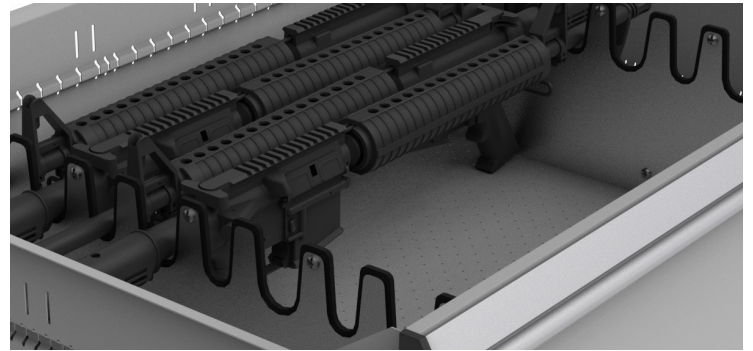

In accordance with defence and security regulations, two welded vertical security bars are included with the cabinet.

The cradles are composed of a rubber strip positioned between two steel sheets, allowing the weapon to be placed without causing damage.

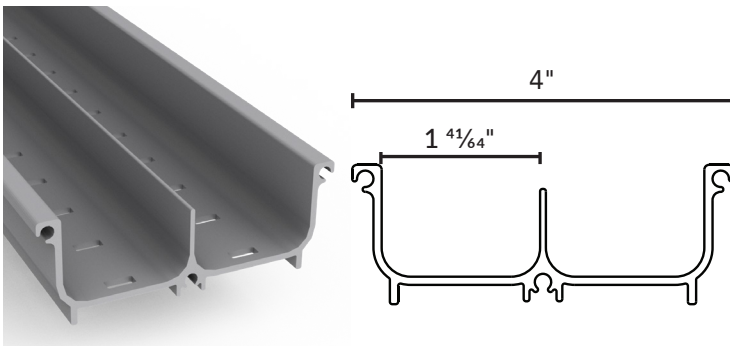

The aluminum compartments allow for easy organization of items and can be further subdivided with plastic dividers.

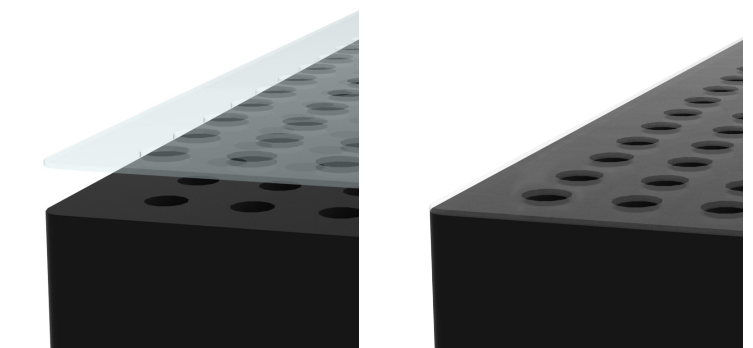

The closed-cell foams and the transparent polycarbonate sheet facilitate the identification of items and help prevent foam damage during use.

# 1 R CABINET WEAPONS TYPE

## 3 EASY STEPS

We offer a three-step process that allows you to easily and quickly create your own layout.



STEP 1: SELECT THE WEAPON OR BOLT TYPE

STEP 2: CHOOSE THE HOUSING

STEP 3: ADD ACCESSORIES AND COMPONENTS

### MACHINE GUNS

### M240 AND C6 TYPE WEAPONS

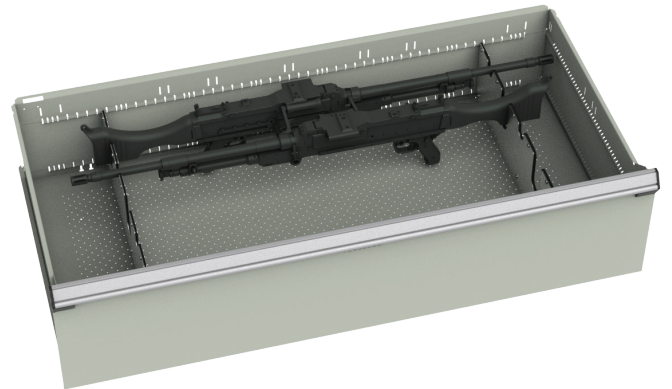
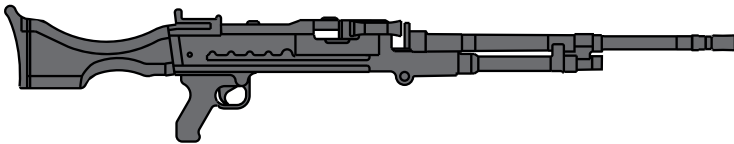

Complete with A for an integrated closed locking mechanism on the drawer.

| PRODUCT NUMBER | NOMINAL DRAWER DIMENSIONS (W × D × H) | INTERNAL DRAWER DIMENSIONS (W × D × H) | NOTCH DIMENSIONS |              | NUMBER OF WEAPONS |
|----------------|---------------------------------------|--|------------------|--------------|-------------------|
|                |                                       |  | FRONT SECTION    | REAR SECTION |                   |
| R81KE-0601014_ | 60" × 24" × 14"                       | 55 ½" × 20 ½" × 13"                    | 1 13/64"         | 2 27/64"     | 4                 |
| R81KH-0601014_ | 60" × 30" × 14"                       | 55 ½" × 26 ½" × 13"                    | 1 3/8"           | 4 1/4"       | 5                 |

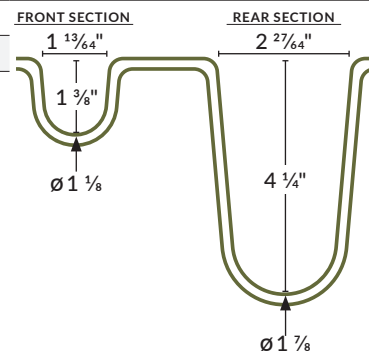

**NOTES:** For bolts for machine guns, see page 8.

These models include one drawer and two cradles.

**ASSAULT RIFLES AND SHOTGUNS** M16, M4, C7, C8 AND SHOTGUN TYPE WEAPONS

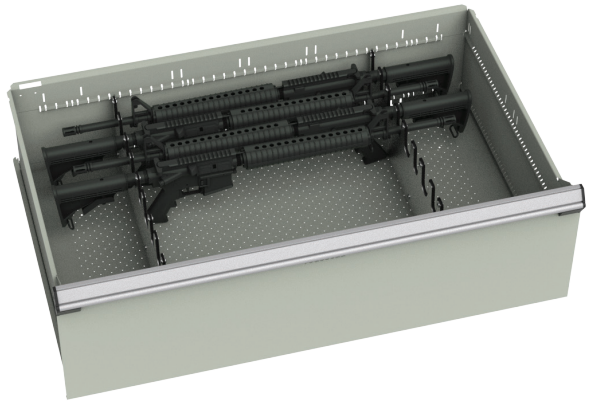
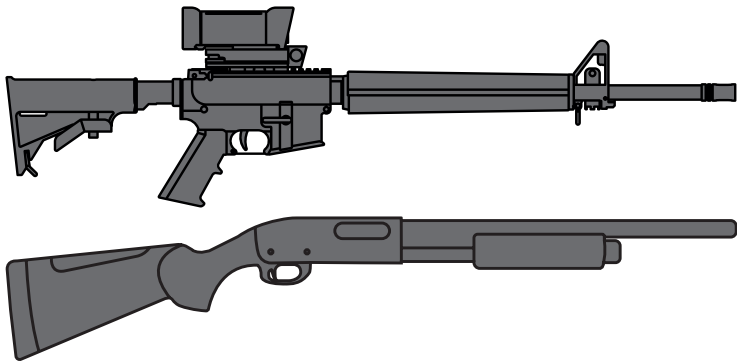

Complete with A for an integrated closed locking mechanism on the drawer.

| PRODUCT NUMBER | NOMINAL DRAWER DIMENSIONS (W×D×H) | INTERNAL DRAWER DIMENSIONS (W×D×H) | NOTCH DIMENSIONS | NUMBER OF WEAPONS |
|----------------|-----------------------------------|------------------------------------|------------------|-------------------|
| R81ME-1001014_ | 45" × 24" × 14"                   | 40 ½" × 20 ½" × 13"                |                  | 7                 |
| R81MH-1001014_ | 45" × 30" × 14"                   | 40 ½" × 26 ½" × 13"                |                  | 10                |
| R81HE-1001014_ | 48" × 24" × 14"                   | 43 ½" × 20 ½" × 13"                |                  | 7                 |
| R81HH-1001014_ | 48" × 30" × 14"                   | 43 ½" × 26 ½" × 13"                |                  | 10                |
| R81KE-1001014_ | 60" × 24" × 14"                   | 55 ½" × 20 ½" × 13"                |                  | 7                 |
| R81KH-1001014_ | 60" × 30" × 14"                   | 55 ½" × 26 ½" × 13"                |                  | 10                |

**NOTES:** For bolts for assault rifles, see page 9.  
These models include one drawer and two cradles.

**LIGHT MACHINE GUNS** M249 AND C9 TYPE WEAPONS

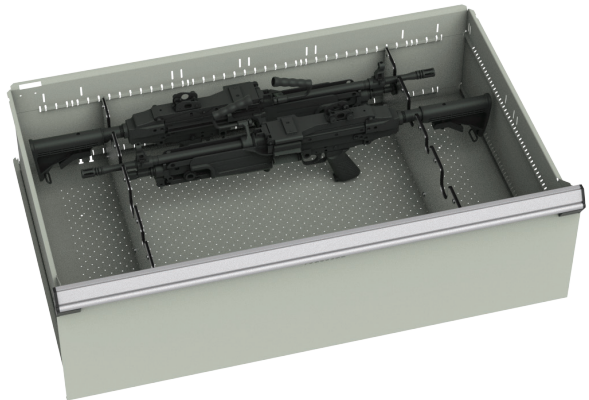
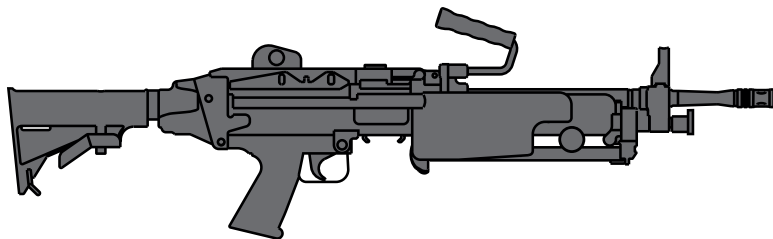

Complete with A for an integrated closed locking mechanism on the drawer.

| PRODUCT NUMBER | NOMINAL DRAWER DIMENSIONS (W×D×H) | INTERNAL DRAWER DIMENSIONS (W×D×H) | NOTCH DIMENSIONS | NUMBER OF WEAPONS |
|----------------|-----------------------------------|------------------------------------|------------------|-------------------|
| R81ME-0901014_ | 45" × 24" × 14"                   | 40 ½" × 20 ½" × 13"                |                  | 2                 |
| R81MH-0901014_ | 45" × 30" × 14"                   | 40 ½" × 26 ½" × 13"                |                  | 3                 |
| R81HE-0901014_ | 48" × 24" × 14"                   | 43 ½" × 20 ½" × 13"                |                  | 4                 |
| R81HH-0901014_ | 48" × 30" × 14"                   | 43 ½" × 26 ½" × 13"                |                  | 5                 |
| R81KE-0901014_ | 60" × 24" × 14"                   | 55 ½" × 20 ½" × 13"                |                  | 4                 |
| R81KH-0901014_ | 60" × 30" × 14"                   | 55 ½" × 26 ½" × 13"                |                  | 5                 |

**NOTES:** For bolts for light machine guns, see page 10.  
These models include one drawer and two cradles.

PRECISION RIFLES / MARKSMAN RIFLES

\*1

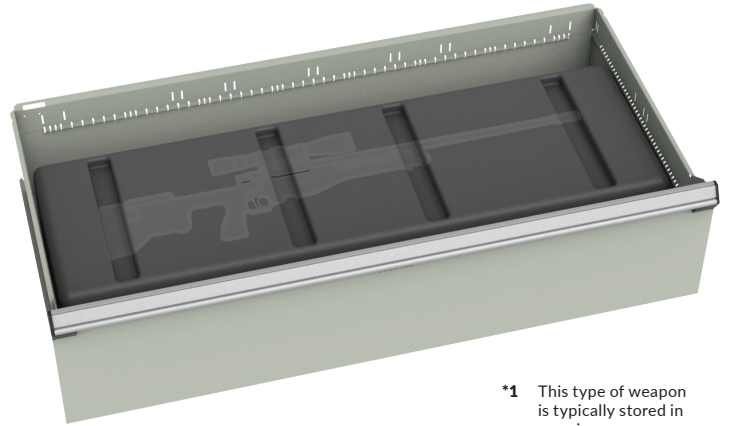
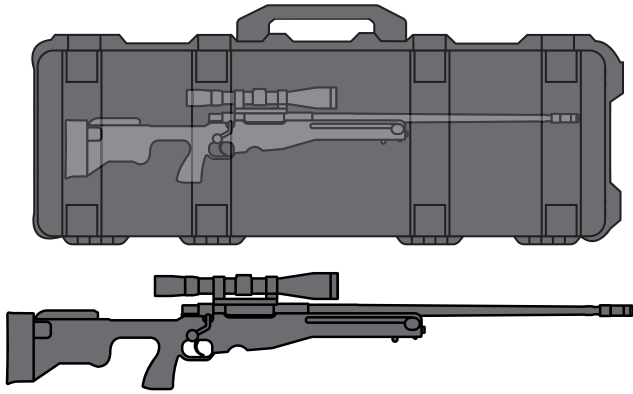

Complete with A for an integrated closed locking mechanism on the drawer.

\*1 This type of weapon is typically stored in carrying cases.

| PRODUCT NUMBER | NOMINAL DRAWER DIMENSIONS (W x D x H) | INTERNAL DRAWER DIMENSIONS (W x D x H) | NUMBER OF WEAPONS |
|----------------|---------------------------------------|--|-------------------|
| RF31-602414_   | 60" x 24" x 14"                       | 55 1/2" x 20 1/2" x 13"                | 1                 |
| RF31-603014_   | 60" x 30" x 14"                       | 55 1/2" x 26 1/2" x 13"                | 1                 |

NOTE: These models include one drawer.

PISTOLS

M17 AND C22 TYPE WEAPONS

The closed-cell foams and the transparent polycarbonate sheet facilitate the identification of items and help prevent foam damage during use.

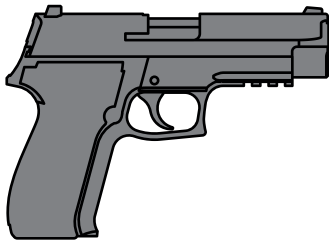

Complete with A for an integrated closed locking mechanism on the drawer.

| PRODUCT NUMBER | NOMINAL DRAWER DIMENSIONS (W x D x H) | INTERNAL DRAWER DIMENSIONS (W x D x H) | NOTCH DIMENSIONS | NUMBER OF WEAPONS |
|----------------|---------------------------------------|--|------------------|-------------------|
| R81ME-2202010_ | 45" x 24" x 10"                       | 40 1/2" x 20 1/2" x 9"                 | <p>*1</p>        | 51                |
| R81MH-2202010_ | 45" x 30" x 10"                       | 40 1/2" x 26 1/2" x 9"                 |                  | 68                |
| R81HE-2202010_ | 48" x 24" x 10"                       | 43 1/2" x 20 1/2" x 9"                 | <p>*2</p>        | 54                |
| R81HH-2202010_ | 48" x 30" x 10"                       | 43 1/2" x 26 1/2" x 9"                 |                  | 72                |
| R81KE-2202010_ | 60" x 24" x 10"                       | 55 1/2" x 20 1/2" x 9"                 |                  | 69                |
| R81KH-2202010_ | 60" x 30" x 10"                       | 55 1/2" x 26 1/2" x 9"                 |                  | 92                |

NOTES: For bolts for pistols, see page 11.

These models include one drawer, closed-cell foam and a transparent polycarbonate sheet.

\*1 For storing weapons with bolts.  
or  
\*2 For storing weapons separately from bolts. See page 11 for pistol bolt storage.

**GRENADE LAUNCHERS, ROCKET LAUNCHERS, HEAVY MACHINE GUNS, ETC.**

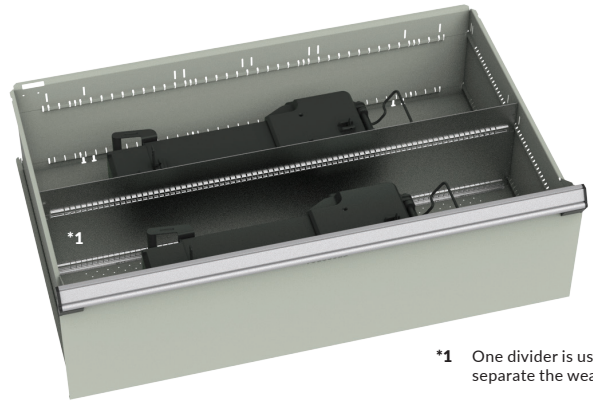
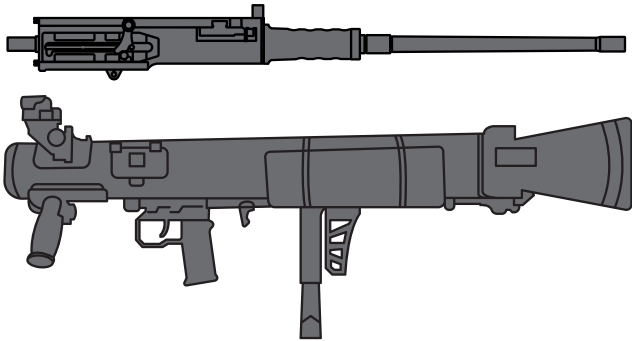

\*1 One divider is used to separate the weapons.

Complete with A for an integrated closed locking mechanism on the drawer.

| PRODUCT NUMBER | NOMINAL DRAWER DIMENSIONS (W x D x H) | INTERNAL DRAWER DIMENSIONS (W x D x H) | NUMBER OF WEAPONS |
|----------------|---------------------------------------|--|-------------------|
| R81ME-0505014_ | 45" x 24" x 14"                       | 40 1/2" x 20 1/2" x 13"                | 2                 |
| R81MH-0505014_ | 45" x 30" x 14"                       | 40 1/2" x 26 1/2" x 13"                | 2                 |
| R81HE-0505014_ | 48" x 24" x 14"                       | 43 1/2" x 20 1/2" x 13"                | 2                 |
| R81HH-0505014_ | 48" x 30" x 14"                       | 43 1/2" x 26 1/2" x 13"                | 2                 |
| R81KE-0505014_ | 60" x 24" x 14"                       | 55 1/2" x 20 1/2" x 13"                | 2                 |
| R81KH-0505014_ | 60" x 30" x 14"                       | 55 1/2" x 26 1/2" x 13"                | 2                 |

**NOTE:** These models include one drawer and one divider.

**MORTARS**

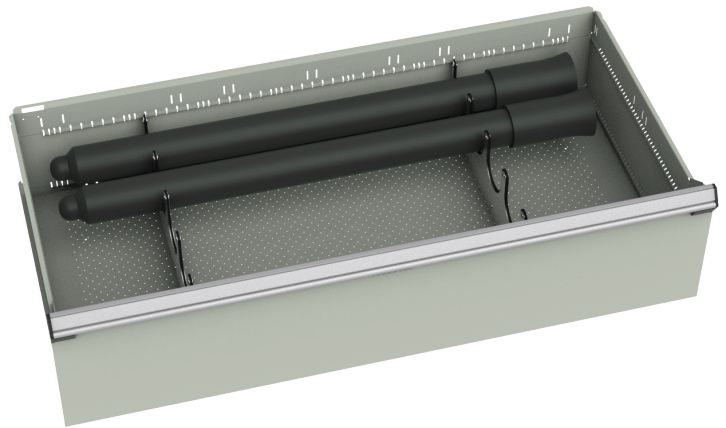
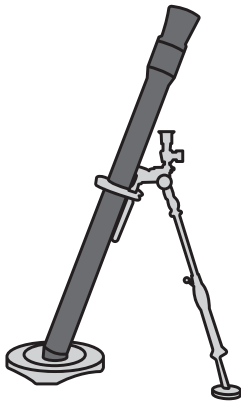

Complete with A for an integrated closed locking mechanism on the drawer.

| PRODUCT NUMBER | NOMINAL DRAWER DIMENSIONS (W x D x H) | INTERNAL DRAWER DIMENSIONS (W x D x H) | NOTCH DIMENSIONS | NUMBER OF WEAPONS |
|----------------|---------------------------------------|--|------------------|-------------------|
| R81KE-0401014_ | 60" x 24" x 14"                       | 55 1/2" x 20 1/2" x 13"                |                  | 3                 |
| R81KH-0401014_ | 60" x 30" x 14"                       | 55 1/2" x 26 1/2" x 13"                |                  | 5                 |

**NOTE:** These models include one drawer and two cradles.

# 1 R CABINET BOLT TYPE

## BOLTS FOR MACHINE GUNS

## BOLTS FOR M240 AND C6 TYPE WEAPONS

**BOLT & OPERATING ROD ASSEMBLY =**  
1 5/8" W x 21-1/16" D x 2 3/4" H APPROX.

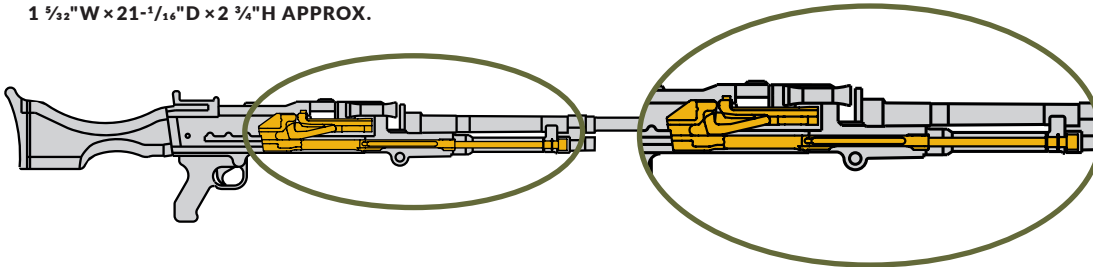

**NOTE:** For machine guns, see page 4.

Complete with A for an integrated closed locking mechanism on the drawer.

### STORAGE WITH GROOVE TRAYS (DEPTH-WISE)

| PRODUCT NUMBER | NOMINAL DRAWER DIMENSIONS (W x D x H) | INTERNAL DRAWER DIMENSIONS (W x D x H) | COMPARTMENT DIMENSIONS (WIDTH: 1 41/64") | NUMBER OF ITEMS |
|----------------|---------------------------------------|--|--|-----------------|
| R81MH-0603005_ | 45" x 30" x 5"                        | 40 1/2" x 26 1/2" x 4"                 | 26 1/2" D                                | 20              |
| R81HH-0603005_ | 48" x 30" x 5"                        | 43 1/2" x 26 1/2" x 4"                 | 26 1/2" D                                | 22              |
| R81KH-0603005_ | 60" x 30" x 5"                        | 55 1/2" x 26 1/2" x 4"                 | 26 1/2" D                                | 30              |

**NOTE:** These models include a drawer, storage with groove trays, and dividers.

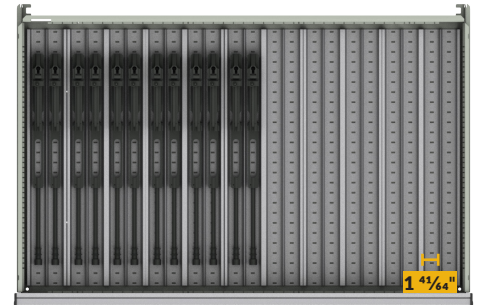

Complete with A for an integrated closed locking mechanism on the drawer.

### STORAGE WITH GROOVE TRAYS (WIDTH-WISE)

| PRODUCT NUMBER | NOMINAL DRAWER DIMENSIONS (W x D x H) | INTERNAL DRAWER DIMENSIONS (W x D x H) | COMPARTMENT DIMENSIONS (DEPTH: 1 41/64") | NUMBER OF ITEMS |
|----------------|---------------------------------------|--|--|-----------------|
| R81ME-0604005_ | 45" x 24" x 5"                        | 40 1/2" x 20 1/2" x 4"                 | 40 1/2" W                                | 10              |
| R81MH-0604005_ | 45" x 30" x 5"                        | 40 1/2" x 26 1/2" x 4"                 | 40 1/2" W                                | 12              |
| R81HE-0604005_ | 48" x 24" x 5"                        | 43 1/2" x 20 1/2" x 4"                 | 21 1/2" W                                | 20              |
| R81HH-0604005_ | 48" x 30" x 5"                        | 43 1/2" x 26 1/2" x 4"                 | 21 1/2" W                                | 24              |
| R81KE-0604005_ | 60" x 24" x 5"                        | 55 1/2" x 20 1/2" x 4"                 | 27 1/2" W                                | 20              |
| R81KH-0604005_ | 60" x 30" x 5"                        | 55 1/2" x 26 1/2" x 4"                 | 27 1/2" W                                | 24              |

**NOTE:** These models include a drawer, storage with groove trays, and dividers.



**BOLTS FOR ASSAULT RIFLES** **BOLTS FOR M16, M4, C7 AND C8 TYPE WEAPONS**

**BOLT ASSEMBLY =**  
7 1/2"W x 1"H APPROX.

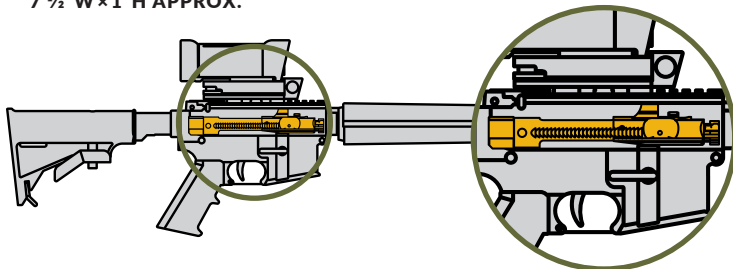

**NOTE:** For assault rifles, see page 5.

Complete with **A** for an integrated closed locking mechanism on the drawer.

**STORAGE WITH FOAM (HEIGHT-WISE)**

| PRODUCT NUMBER | NOMINAL DRAWER DIMENSIONS (W x D x H) | INTERNAL DRAWER DIMENSIONS (W x D x H) | COMPARTMENT DIMENSIONS (DIAMETER: 1 1/4") | NUMBER OF ITEMS |
|----------------|---------------------------------------|--|---|-----------------|
| R81ME-1002010_ | 45" x 24" x 10"                       | 40 1/2" x 20 1/2" x 9"                 | 3"H                                       | 171             |
| R81MH-1002010_ | 45" x 30" x 10"                       | 40 1/2" x 26 1/2" x 9"                 | 3"H                                       | 228             |
| R81HE-1002010_ | 48" x 24" x 10"                       | 43 1/2" x 20 1/2" x 9"                 | 3"H                                       | 189             |
| R81HH-1002010_ | 48" x 30" x 10"                       | 43 1/2" x 26 1/2" x 9"                 | 3"H                                       | 252             |
| R81KE-1002010_ | 60" x 24" x 10"                       | 55 1/2" x 20 1/2" x 9"                 | 3"H                                       | 243             |
| R81KH-1002010_ | 60" x 30" x 10"                       | 55 1/2" x 26 1/2" x 9"                 | 3"H                                       | 324             |

**NOTE:** These models include a drawer and a foam storage.

Complete with **A** for an integrated closed locking mechanism on the drawer.

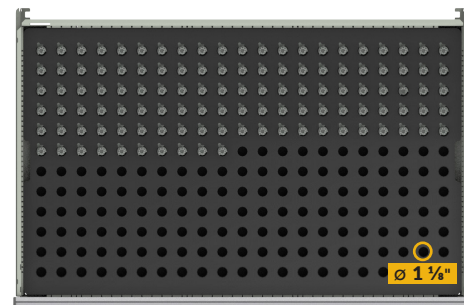

**STORAGE WITH GROOVE TRAYS (DEPTH-WISE)**

| PRODUCT NUMBER | NOMINAL DRAWER DIMENSIONS (W x D x H) | INTERNAL DRAWER DIMENSIONS (W x D x H) | COMPARTMENT DIMENSIONS (WIDTH: 1 4/64") | NUMBER OF ITEMS |
|----------------|---------------------------------------|--|---|-----------------|
| R81ME-1003005_ | 45" x 24" x 5"                        | 40 1/2" x 20 1/2" x 4"                 | 7 1/32"D                                | 40              |
| R81MH-1003005_ | 45" x 30" x 5"                        | 40 1/2" x 26 1/2" x 4"                 | 7 1/32"D                                | 60              |
| R81HE-1003005_ | 48" x 24" x 5"                        | 43 1/2" x 20 1/2" x 4"                 | 7 1/32"D                                | 44              |
| R81HH-1003005_ | 48" x 30" x 5"                        | 43 1/2" x 26 1/2" x 4"                 | 7 1/32"D                                | 66              |
| R81KE-1003005_ | 60" x 24" x 5"                        | 55 1/2" x 20 1/2" x 4"                 | 7 1/32"D                                | 60              |
| R81KH-1003005_ | 60" x 30" x 5"                        | 55 1/2" x 26 1/2" x 4"                 | 7 1/32"D                                | 90              |

**NOTE:** These models include a drawer, storage with groove trays, and dividers.

Complete with **A** for an integrated closed locking mechanism on the drawer.

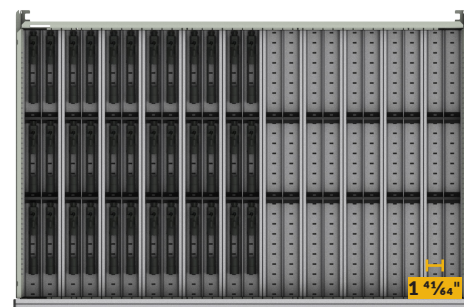

**STORAGE WITH GROOVE TRAYS (WIDTH-WISE)**

| PRODUCT NUMBER | NOMINAL DRAWER DIMENSIONS (W x D x H) | INTERNAL DRAWER DIMENSIONS (W x D x H) | COMPARTMENT DIMENSIONS (DEPTH: 1 4/64") | NUMBER OF ITEMS |
|----------------|---------------------------------------|--|---|-----------------|
| R81ME-1004005_ | 45" x 24" x 5"                        | 40 1/2" x 20 1/2" x 4"                 | 7 1/32"W                                | 50              |
| R81MH-1004005_ | 45" x 30" x 5"                        | 40 1/2" x 26 1/2" x 4"                 | 7 1/32"W                                | 60              |
| R81HE-1004005_ | 48" x 24" x 5"                        | 43 1/2" x 20 1/2" x 4"                 | 7 1/32"W                                | 50              |
| R81HH-1004005_ | 48" x 30" x 5"                        | 43 1/2" x 26 1/2" x 4"                 | 7 1/32"W                                | 60              |
| R81KE-1004005_ | 60" x 24" x 5"                        | 55 1/2" x 20 1/2" x 4"                 | 7 1/32"W                                | 60              |
| R81KH-1004005_ | 60" x 30" x 5"                        | 55 1/2" x 26 1/2" x 4"                 | 7 1/32"W                                | 72              |

**NOTE:** These models include a drawer, storage with groove trays, and dividers.



## BOLTS FOR LIGHT MACHINE GUNS

## BOLTS FOR M249 AND C9 TYPE WEAPONS

**BOLT =**  
 $2 \frac{4}{64}''$ W  $\times$   $0 \frac{4}{64}''$ H APPROX.

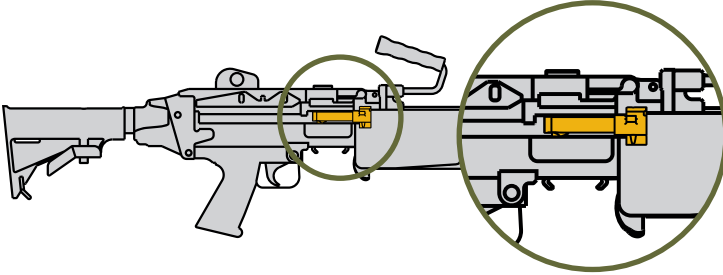

**NOTE:** For light machine guns, see page 5.

Complete with A for an integrated closed locking mechanism on the drawer.

## STORAGE WITH GROOVE TRAYS (DEPTH-WISE)

| PRODUCT NUMBER | NOMINAL DRAWER DIMENSIONS (W × D × H) | INTERNAL DRAWER DIMENSIONS (W × D × H) | COMPARTMENT DIMENSIONS (WIDTH: $1 \frac{4}{64}''$ ) | NUMBER OF ITEMS |
|----------------|---------------------------------------|--|---|-----------------|
| R81ME-0903005_ | 45" × 24" × 5"                        | 40 ½" × 20 ½" × 4"                     | 3 ⅜"D   | 100             |
| R81MH-0903005_ | 45" × 30" × 5"                        | 40 ½" × 26 ½" × 4"                     | 3 ⅜"D   | 120             |
| R81HE-0903005_ | 48" × 24" × 5"                        | 43 ½" × 20 ½" × 4"                     | 3 ⅜"D   | 110             |
| R81HH-0903005_ | 48" × 30" × 5"                        | 43 ½" × 26 ½" × 4"                     | 3 ⅜"D   | 132             |
| R81KE-0903005_ | 60" × 24" × 5"                        | 55 ½" × 20 ½" × 4"                     | 3 ⅜"D   | 150             |
| R81KH-0903005_ | 60" × 30" × 5"                        | 55 ½" × 26 ½" × 4"                     | 3 ⅜"D   | 180             |

**NOTE:** These models include a drawer, storage with groove trays, and dividers.



Complete with A for an integrated closed locking mechanism on the drawer.

## STORAGE WITH GROOVE TRAYS (WIDTH-WISE)

| PRODUCT NUMBER | NOMINAL DRAWER DIMENSIONS (W × D × H) | INTERNAL DRAWER DIMENSIONS (W × D × H) | COMPARTMENT DIMENSIONS (DEPTH: $1 \frac{4}{64}''$ ) | NUMBER OF ITEMS |
|----------------|---------------------------------------|--|---|-----------------|
| R81ME-0904005_ | 45" × 24" × 5"                        | 40 ½" × 20 ½" × 4"                     | 3 ⅜"W   | 100             |
| R81MH-0904005_ | 45" × 30" × 5"                        | 40 ½" × 26 ½" × 4"                     | 3 ⅜"W   | 120             |
| R81HE-0904005_ | 48" × 24" × 5"                        | 43 ½" × 20 ½" × 4"                     | 3 ⅜"W   | 110             |
| R81HH-0904005_ | 48" × 30" × 5"                        | 43 ½" × 26 ½" × 4"                     | 3 ⅜"W   | 130             |
| R81KE-0904005_ | 60" × 24" × 5"                        | 55 ½" × 20 ½" × 4"                     | 3 ⅜"W   | 140             |
| R81KH-0904005_ | 60" × 30" × 5"                        | 55 ½" × 26 ½" × 4"                     | 3 ⅜"W   | 168             |

**NOTE:** These models include a drawer, storage with groove trays, and dividers.

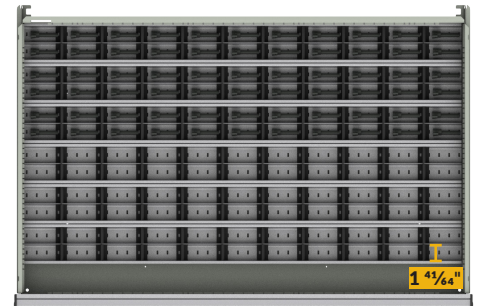

**PISTOL SLIDES** SLIDES FOR M17 AND C22 TYPE WEAPONS

**BOLT ONLY =**  
**7 13/64"W x 1 1/2"D x 1"H APPROX.**

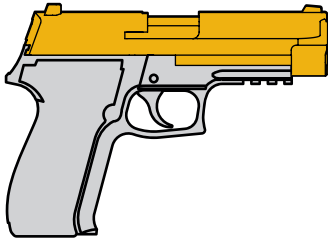

**NOTE:** For pistols, see page 6.

Complete with A for an integrated closed locking mechanism on the drawer.

**STORAGE WITH GROOVE TRAYS (DEPTH-WISE)**

| PRODUCT NUMBER | NOMINAL DRAWER DIMENSIONS (W x D x H) | INTERNAL DRAWER DIMENSIONS (W x D x H) | COMPARTMENT DIMENSIONS (WIDTH: 1 41/64") | NUMBER OF ITEMS |
|----------------|---------------------------------------|--|--|-----------------|
| R81ME-2203005_ | 45" x 24" x 5"                        | 40 1/2" x 20 1/2" x 4"                 | 8 19/32"D                                | 40              |
| R81MH-2203005_ | 45" x 30" x 5"                        | 40 1/2" x 26 1/2" x 4"                 | 8 19/32"D                                | 60              |
| R81HE-2203005_ | 48" x 24" x 5"                        | 43 1/2" x 20 1/2" x 4"                 | 8 19/32"D                                | 44              |
| R81HH-2203005_ | 48" x 30" x 5"                        | 43 1/2" x 26 1/2" x 4"                 | 8 19/32"D                                | 66              |
| R81KE-2203005_ | 60" x 24" x 5"                        | 55 1/2" x 20 1/2" x 4"                 | 8 19/32"D                                | 60              |
| R81KH-2203005_ | 60" x 30" x 5"                        | 55 1/2" x 26 1/2" x 4"                 | 8 19/32"D                                | 90              |

**NOTE:** These models include a drawer, storage with groove trays, and dividers.

Complete with A for an integrated closed locking mechanism on the drawer.

**STORAGE WITH GROOVE TRAYS (WIDTH-WISE)**

| PRODUCT NUMBER | NOMINAL DRAWER DIMENSIONS (W x D x H) | INTERNAL DRAWER DIMENSIONS (W x D x H) | COMPARTMENT DIMENSIONS (DEPTH: 1 41/64") | NUMBER OF ITEMS |
|----------------|---------------------------------------|--|--|-----------------|
| R81ME-2204005_ | 45" x 24" x 5"                        | 40 1/2" x 20 1/2" x 4"                 | 8 19/32"W                                | 40              |
| R81MH-2204005_ | 45" x 30" x 5"                        | 40 1/2" x 26 1/2" x 4"                 | 8 19/32"W                                | 48              |
| R81HE-2204005_ | 48" x 24" x 5"                        | 43 1/2" x 20 1/2" x 4"                 | 8 19/32"W                                | 50              |
| R81HH-2204005_ | 48" x 30" x 5"                        | 43 1/2" x 26 1/2" x 4"                 | 8 19/32"W                                | 60              |
| R81KE-2204005_ | 60" x 24" x 5"                        | 55 1/2" x 20 1/2" x 4"                 | 8 19/32"W                                | 60              |
| R81KH-2204005_ | 60" x 30" x 5"                        | 55 1/2" x 26 1/2" x 4"                 | 8 19/32"W                                | 72              |

**NOTE:** These models include a drawer, storage with groove trays, and dividers.

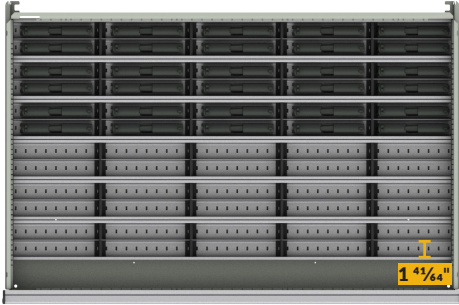
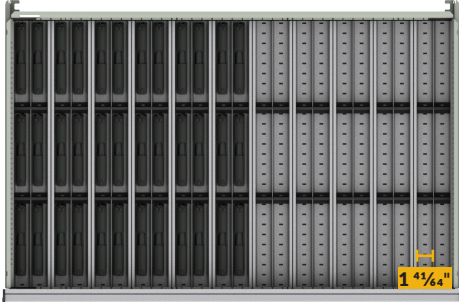

## 2 CABINET R HOUSING

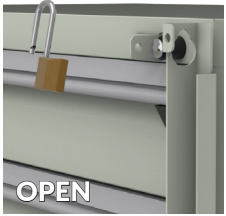

In accordance with military base safety regulations, two welded vertical security bars are included with the cabinet.

For the mobile version, add an A to the product number, e.g., RABR-452430A for a 45"W, 24"D and 30"H cabinet in the mobile version.

| PRODUCT NUMBER | W×D×H    | INTERIOR HEIGHT |
|----------------|----------|-----------------|
| RABR-452430_   | 45×24×30 | 26              |
| RABR-452434_   | 45×24×34 | 30              |
| RABR-452438_   | 45×24×38 | 34              |
| RABR-452444_   | 45×24×44 | 40              |
| RABR-452458_   | 45×24×58 | 54              |
| RABR-453030_   | 45×30×30 | 26              |
| RABR-453034_   | 45×30×34 | 30              |
| RABR-453038_   | 45×30×38 | 34              |
| RABR-453044_   | 45×30×44 | 40              |
| RABR-453058_   | 45×30×58 | 54              |
| RABR-482430_   | 48×24×30 | 26              |
| RABR-482434_   | 48×24×34 | 30              |
| RABR-482438_   | 48×24×38 | 34              |
| RABR-482444_   | 48×24×44 | 40              |
| RABR-482458_   | 48×24×58 | 54              |
| RABR-483030_   | 48×30×30 | 26              |
| RABR-483034_   | 48×30×34 | 30              |
| RABR-483038_   | 48×30×38 | 34              |
| RABR-483044_   | 48×30×44 | 40              |
| RABR-483058_   | 48×30×58 | 54              |
| RABR-602430_   | 60×24×30 | 26              |
| RABR-602434_   | 60×24×34 | 30              |
| RABR-602438_   | 60×24×38 | 34              |
| RABR-602444_   | 60×24×44 | 40              |
| RABR-602458_   | 60×24×58 | 54              |
| RABR-603030_   | 60×30×30 | 26              |
| RABR-603034_   | 60×30×34 | 30              |
| RABR-603038_   | 60×30×38 | 34              |
| RABR-603044_   | 60×30×44 | 40              |
| RABR-603058_   | 60×30×58 | 54              |

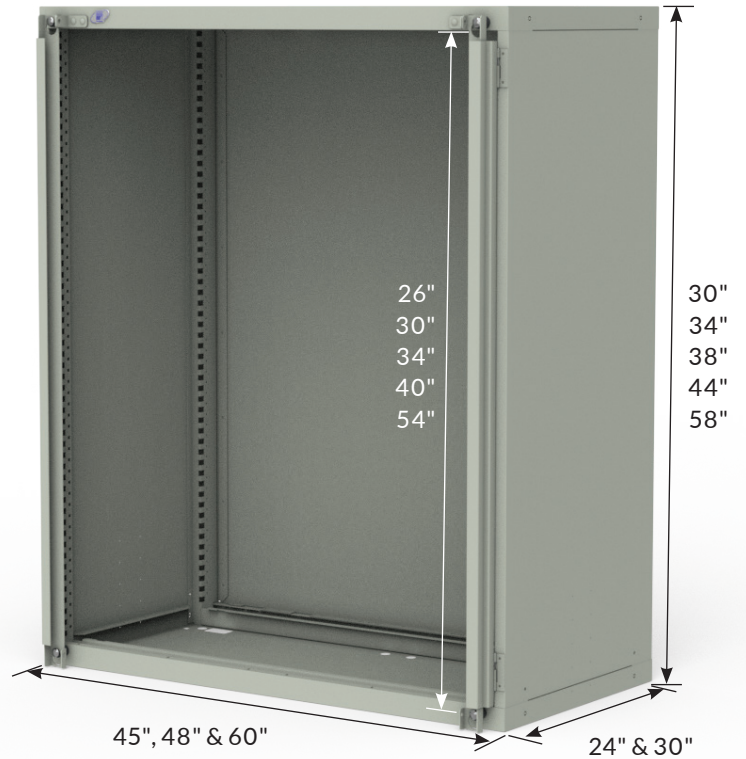

**NOTES:** The cabinet can accommodate drawers for weapon storage and RF31 drawers or RF40 shelves to optimize the available space, [see page 14](#).

For safety reasons, it is mandatory to have a security mechanism A either on the drawers or on the cabinet for mobile versions.

# 3 CABINET R ACCESSORIES

## CABINET TOPS

### STEEL TOP WITH RUBBER MAT

RC32



- 1/8"-thick non-slip neoprene surface
- Includes edges on the sides and back
- Height: 1"

### STAINLESS STEEL TOP

RC35



- 16ga stainless steel
- Acts as a work surface and protects the cabinet from impacts
- Particulate board top with stainless steel cover (#4 brushed finish)
- Excellent corrosion and chemical resistance
- Top complies with CARB regulations on formaldehyde emissions
- Thickness: 1 3/4"

### PAINTED STEEL TOP

RC37



- Acts as a work surface and protects the cabinet from impacts
- Particulate board top with painted cover
- Top complies with CARB regulations on formaldehyde emissions
- Thickness: 1 3/4"

### LAMINATED HARDWOOD TOP

WS14



- Top for general industrial applications
- Made from varnished hardwood slats
- Includes a 90° radius front edge for extra comfort
- High impact resistance
- Thickness: 1 3/4"

## DIMENSIONS

| W   | D   | LAMINATED HARDWOOD | STEEL WITH RUBBER MAT | STAINLESS STEEL | PAINTED STEEL |
|-----|-----|--------------------|-----------------------|-----------------|---------------|
| 45" | 24" | WS14-4524A         | RC32-4524-01          | RC35-4524       | RC37-4524     |
|     | 30" | WS14-4530A         | RC32-4530-01          | RC35-4530       | RC37-4530     |
| 48" | 24" | WS14-4824A         | RC32-4824-01          | RC35-4824       | RC37-4824     |
|     | 30" | WS14-4830A         | RC32-4830-01          | RC35-4830       | RC37-4830     |
| 60" | 24" | WS14-6024A         | RC32-6024-01          | RC35-6024       | RC37-6024     |
|     | 30" | WS14-6030A         | RC32-6030-01          | RC35-6030       | RC37-6030     |

## DRAWERS

## HEAVY-DUTY MODULAR DRAWER

RF31



- 400lb. load capacity, 100% extension
- Heavy-duty construction
- Easy to install
- Drawer heights available: 3", 4", 5", 6", 7", 8", 9", 10", 12" and 14"
- To order: Add the drawer height to the product number, e.g.,: RF31-452406
- Complete with **A** for an integrated lock-in mechanism on the drawer

| PRODUCT NUMBER | W x D     |
|----------------|-----------|
| RF31-4524__    | 45" x 24" |
| RF31-4530__    | 45" x 30" |
| RF31-4824__    | 48" x 24" |
| RF31-4830__    | 48" x 30" |
| RF31-6024__    | 60" x 24" |
| RF31-6030__    | 60" x 30" |

## HEAVY-DUTY ROLL-OUT SHELF (FRONT ACCESS)

RF40



- 400lb. load capacity, 100% extension
- Heavy-duty construction
- Easy to install
- Painted steel with 3"H edges on the sides and back
- Total height: 6"
- Full access to contents
- Complete with **A** for an integrated lock-in mechanism on the shelf

| PRODUCT NUMBER | W x D     |
|----------------|-----------|
| RF40-4524      | 45" x 24" |
| RF40-4530      | 45" x 30" |
| RF40-4824      | 48" x 24" |
| RF40-4830      | 48" x 30" |
| RF40-6024      | 60" x 24" |
| RF40-6030      | 60" x 30" |

## BASES AND ACCESSORIES FOR CABINET MOBILITY

## FORKLIFT BASE (FRONT ACCESS)

RA52



- 2"H base used for moving the cabinet from the front with a forklift
- Includes a front kick plate
- Front kick plate is recessed to allow users to stand closer to the cabinet
- Designed so the cabinet can be anchored to the floor

| PRODUCT NUMBER | W x D     |
|----------------|-----------|
| RA52-452402    | 45" x 24" |
| RA52-453002    | 45" x 30" |
| RA52-482402    | 48" x 24" |
| RA52-483002    | 48" x 30" |
| RA52-602402    | 60" x 24" |
| RA52-603002    | 60" x 30" |

**NOTES:** Non compatible with casters.

Compatible with leveling glide kit (RA74).

Angled kick plate available: RA54-LL02

## FORKLIFT BASE (FRONT AND SIDE ACCESS)

RA53

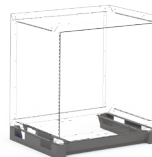

- 4"H base used for moving the cabinet from the front or side with a forklift, or from the front with a pallet-jack
- Includes a front kick plate
- Front kick plate is recessed to allow users to stand closer to the cabinet
- Designed so the cabinet can be anchored to the floor

| PRODUCT NUMBER | W x D     |
|----------------|-----------|
| RA53-452404    | 45" x 24" |
| RA53-453004    | 45" x 30" |
| RA53-482404    | 48" x 24" |
| RA53-483004    | 48" x 30" |
| RA53-602404    | 60" x 24" |
| RA53-603004    | 60" x 30" |

**NOTES:** Non compatible with casters.

Compatible with leveling glide kit (RA74).

Angled kick plate available: RA54-LL04

**LEVELING GLIDE KIT RA74**

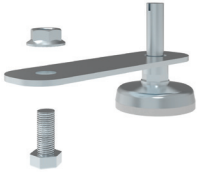

- Sold in kits of 4
- Adjusts the height of cabinets 1 1/8" to 2" on uneven floor surfaces

**PRODUCT NUMBER**  
RA74-01

**HANDLE (SIDE) RB90**



- Installs on the side of cabinets. Specify which side when ordering (left or right)
- Anodized aluminum with heavy-duty plastic end caps
- Wide-grip handle for easier cabinet handling

| PRODUCT NUMBER | HANDLE WIDTH | FOR CABINET |
|----------------|--------------|-------------|
| RB90-24        | 21"          | 24"D        |
| RB90-30        | 27"          | 30"D        |

**CASTERS**

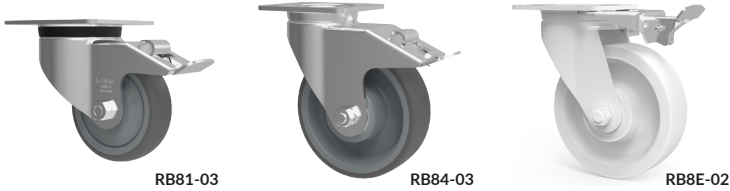

- Sold in pairs
- Three types of casters available: rigid, swivel and swivel with total-lock brake (on wheel and swivel)
- Dark gray, non-marking polyurethane tread
- Superior industrial quality

| PRODUCT NUMBER | CASTER TYPE  | CAPACITY | HEIGHT |        |
|----------------|--|----------|--------|--------|
|                |  |          | WHEEL  | TOTAL  |
| RB84-01        | Rigid  | 1100 lb  | 6"     | 7 1/2" |
| RB84-02        | Swivel   | 1100 lb  | 6"     | 7 1/2" |
| RB84-03        | Swivel with total-lock brake                                   | 1100 lb  | 6"     | 7 1/2" |
| RB8E-02        | SWivel caster directional locking kit for swivel casters (x 2) |          |        |        |

**NOTE:** The casters install directly under an R cabinet (without base).

# 1 R2V CABINET WEAPON TYPE

## 3 EASY STEPS

We offer a three-step process that will allow you to easily and quickly create your own layout.



STEP 1: SELECT THE WEAPON TYPE

STEP 2: CHOOSE THE CABINET

STEP 3: ADD ACCESSORIES AND COMPONENTS

## RIFLES AND SHOTGUNS

## M16, M4, C7, C8 AND SHOTGUN TYPE WEAPONS

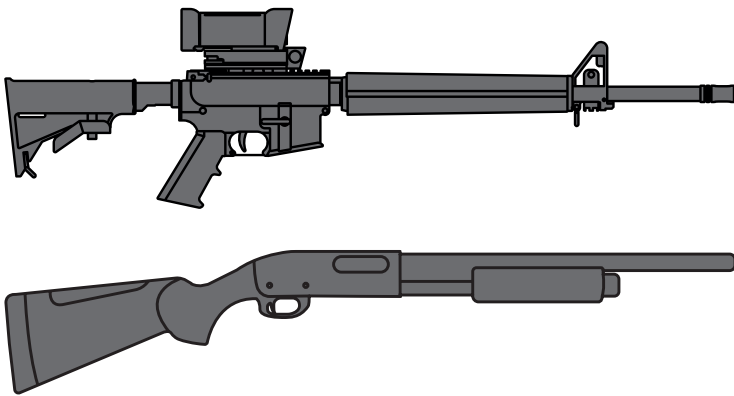

Complete with A for an integrated closed locking mechanism on the drawer.



| PRODUCT NUMBER | NOMINAL DRAWER DIMENSIONS (W × D × H) | INTERNAL DRAWER DIMENSIONS (W × D × H) | NOTCH DIMENSIONS |     | NUMBER OF WEAPONS |
|----------------|---------------------------------------|--|------------------|-----|-------------------|
|                |                                       |  | BOTTOM           | TOP |                   |
| RL812EJ-11010_ | 12" × 24" × 48"                       | 10 11/16" × 19" × 46 7/32"             | 2 1/8"           |     | 5                 |
| RL812HJ-11010_ | 12" × 30" × 48"                       | 10 11/16" × 25" × 46 7/32"             |                  |     | 7                 |

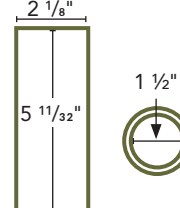

**NOTES:** These models include a bottom support, a multi-position top support, and a side utility panel.

To add a one-drawer-at-a-time mechanism, add A to the product number, e.g., RL812HJ-11010A

**MULTIPLE UPPER SUPPORT** **RLAF**

Compatible with the single upper support  
 Designed for full-depth installation  
 Height-adjustable

| PRODUCT NUMBER | SUPPORT DEPTH | DEPTH | SUPPORT DIMENSIONS |
|----------------|---------------|-------|--------------------|
| RLAF-24        | 4 3/64"       | 24"   |                    |
| RLAF-30        | 4 3/64"       | 30"   |                    |

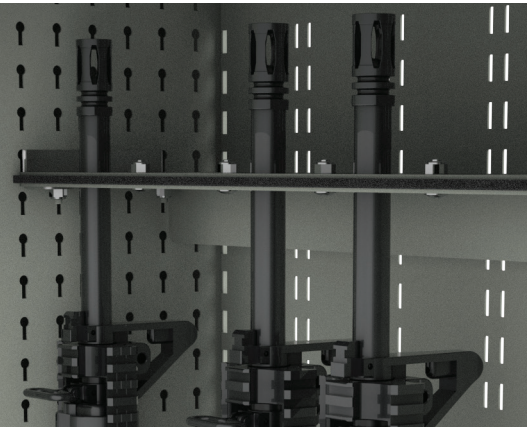
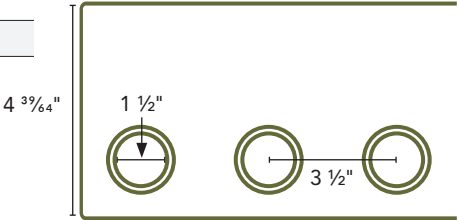

**SINGLE UPPER SUPPORT** **RLAH**

Compatible with the multiple upper support  
 Installs by hooking anywhere onto the RLAK side hanging panel

| PRODUCT NUMBER | SUPPORT WIDTH    | SUPPORT HEIGHT | SUPPORT DIMENSIONS |
|----------------|------------------|----------------|--------------------|
| RLAH-01        | 3 1/2" (4 holes) | 5" (5 holes)   |                    |

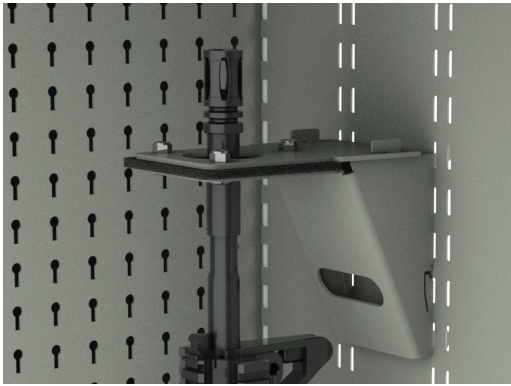
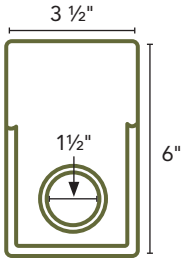

**EXAMPLES OF AVAILABLE CONFIGURATIONS**

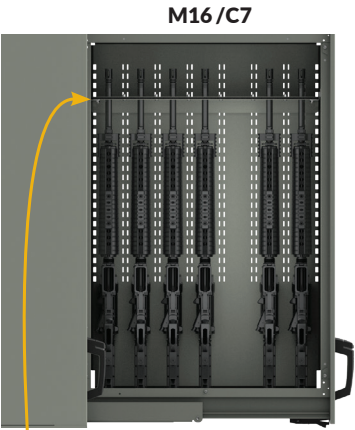

**MULTIPLE UPPER SUPPORT**

Weapons of the same height (longer)  
 The multiple upper support is positioned higher

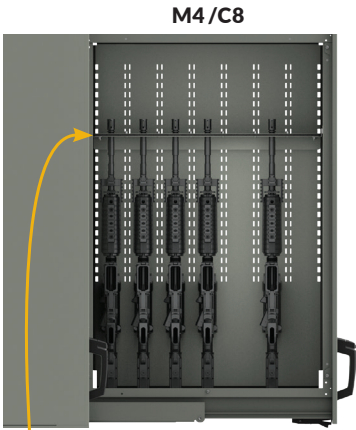

**MULTIPLE UPPER SUPPORT**

Weapons of the same height (shorter)  
 The multiple upper support is positioned lower

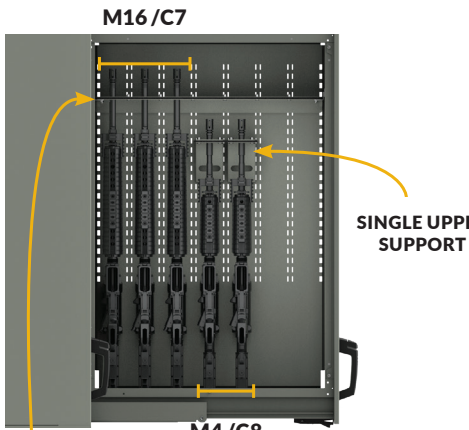

**MULTIPLE UPPER SUPPORT**

**SINGLE UPPER SUPPORT**

Weapons of different heights  
 To combine two types of weapons in a single drawer, the longer weapons are installed in the multiple upper support and the shorter ones in the single upper supports

## 2 R2V CABINET HOUSING AND DRAWERS

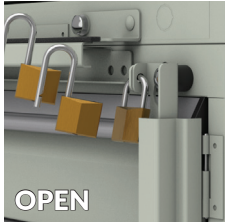

In accordance with defence and security regulations, a welded horizontal security bar is included with the cabinet.

The bar allows the use of two padlocks.

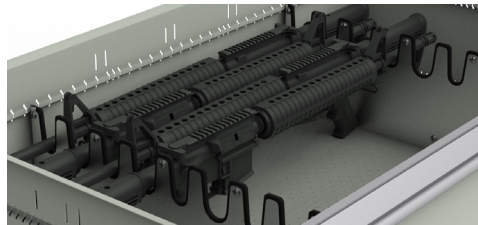

The racks are made of a rubber strip sandwiched between two steel sheets, allowing the weapon to be placed down without damaging it.

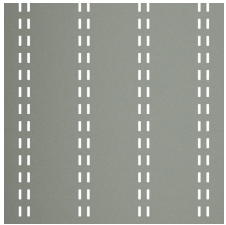

Panels specifically designed to accommodate a single upper support (RLAH).

Complete the product number with A, e.g., RLAJ-452448A for a cabinet measuring 45"L, 24"D, and 48"H with the one-drawer-at-a-time safety mechanism.

| PRODUCT NUMBER | W x D x H       |
|----------------|-----------------|
| RLAJ-452448_   | 45" x 24" x 48" |
| RLAJ-453048_   | 45" x 30" x 48" |
| RLAJ-482448_   | 48" x 24" x 48" |
| RLAJ-483048_   | 48" x 30" x 48" |
| RLAJ-602448_   | 60" x 24" x 48" |
| RLAJ-603048_   | 60" x 30" x 48" |

| CABINET WIDTH | AVAILABLE DRAWER WIDTH RANGE |
|---------------|------------------------------|
| 45"           | 43"                          |
| 48"           | 46"                          |
| 60"           | 58"                          |



**NOTES:** The cabinet can be fitted with weapon storage drawers and RL31 drawers to complete the available space, [see above](#).

The vertical drawer storage must be installed on an R cabinet of the same width and cannot be placed directly on the floor.

**VERTICAL DRAWER RL31**



- 200lb. load capacity, 100% extension
- Interior color: light gray 071
- Front and back inner panels with perforations for hanging tools
- Heavy-duty construction
- Drawer widths available: 10", 11" and 12"
- To order: Add the drawer height to the product number, e.g.,: RL31-102448\_
- Complete with A for an integrated lock-in mechanism on the drawer

| PRODUCT NUMBER | W x D     |
|----------------|-----------|
| RL31-102448_   | 10" x 24" |
| RL31-103048_   | 10" x 30" |
| RL31-112448_   | 11" x 24" |
| RL31-113048_   | 11" x 30" |
| RL31-122448_   | 12" x 24" |
| RL31-123048_   | 12" x 30" |

**FLOOR-STANDING CABINET RA30**



- Can accommodate modular drawers, sliding shelves, and shelves
- Dimensions depend on the vertical drawer cabinet placed on top
- Choice of four locking options: L3 key lock, LP hasp lock, L50 digital code lock and L100 smart lock

**SIDE PANEL FOR WEAPON STORAGE RLAK**



- Allows hanging single upper supports (RLAH) only
- Create a separation between the drawers
- Full-height and full-depth panel
- 1" c/c height increments between holes
- Color: Light Gray 071

| PRODUCT NUMBER | DEPTH |
|----------------|-------|
| RLAK-2448      | 24"   |
| RLAK-3048      | 30"   |

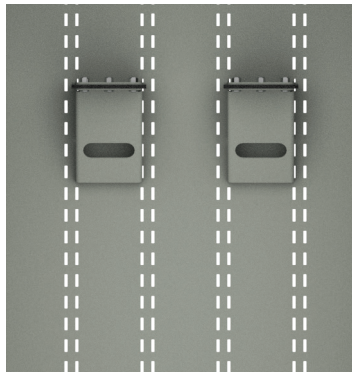

**SINGLE UPPER SUPPORT**

# 3 R2V CABINET ACCESSORIES

## HOOKS

### LIGHT-DUTY HOOKS

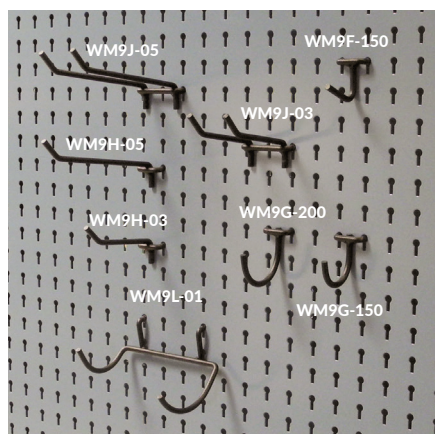

- Our family of hooks makes it possible for you to store several types of parts
- Rousseau utility panels (RL40, RL43)
- Color: black

| TYPE/PACK                   | DIMENSIONS    | PRODUCT NO. |
|-----------------------------|---------------|-------------|
| Straight hooks/20           | 1½" D         | WM9F-150    |
| Single hooks/20             | 1½" dia.      | WM9G-150    |
| Single hooks/20             | 2" dia.       | WM9G-200    |
| Double back single hooks/10 | 3" D          | WM9H-03     |
| Double back single hooks/10 | 5" D          | WM9H-05     |
| Double back double hooks/10 | 3" D          | WM9J-03     |
| Double back double hooks/10 | 5" D          | WM9J-05     |
| Drill holder/1              | 5"W x 3 1/2"D | WM9L-01     |

NOTE: The brackets and hooks are compatible with perforated panels with 1/4" diameter holes located every 1" c/c.

### HEAVY-DUTY SQUARE HOOK

WM9A

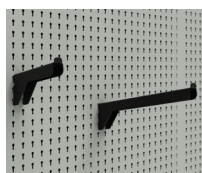

- Flat surface on top
- Raised end to prevent accessories or tools from sliding off
- Hook-on installation
- Includes side notches for extra stability
- 50lb. load capacity
- Sold individually
- 1"W (two holes)
- Color: black

| PRODUCT NO. | LENGTH |
|-------------|--------|
| WM9A-03     | 3"     |
| WM9A-06     | 6"     |
| WM9A-12     | 12"    |

### HEAVY-DUTY ROUND HOOK

WM9B

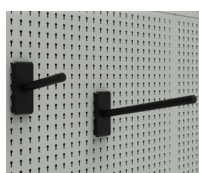

- ¾" dia. tube
- Tools and accessories slide on and off easily
- Hook-on installation
- Includes side notches for extra stability
- 50lb. load capacity
- Sold individually
- Hook base: 2"W (three holes) x 5"H
- Color: black

| PRODUCT NO. | LENGTH |
|-------------|--------|
| WM9B-03     | 3"     |
| WM9B-06     | 6"     |
| WM9B-12     | 12"    |

**VERTICAL DRAWER INTERIORS**

**SIDE UTILITY PANEL RL40**



- For locating tools quickly and easily
- Full-height and full-depth panel
- Color: light gray 071
- Depths available: 24" (18 holes) and 30" (24 holes)

| PRODUCT NO. | CABINET DEPTH | CABINET HEIGHT |
|-------------|---------------|----------------|
| RL40-2448   | 24"           | 48"            |
| RL40-3048   | 30"           | 48"            |

NOTE: Not compatible with weapon storage supports.

**ADJUSTABLE UTILITY PANEL RL43**



- Full-height and full-depth panel
- Tools can be hung on each side of the panel without obstructing the drawer
- Width adjustable in 1/2" increments c/c
- Color: light gray 071
- Depths available: 24" (18 holes) and 30" (24 holes)

| PRODUCT NO. | CABINET DEPTH | CABINET HEIGHT |
|-------------|---------------|----------------|
| RL43-2448   | 24"           | 48"            |
| RL43-3048   | 30"           | 48"            |

NOTE: Not compatible with weapon storage supports.

**ADJUSTABLE TRAY RL21**



- Tool-free installation and adjustment
- Includes edges to prevent objects from falling to the bottom of the drawer
- Height adjustable in 1" increments c/c
- Compatible with side utility panels
- Color: light gray 071
- Widths available: 05", 06", 07", 08", 09", 10", 11" and 12"
- To order: Specify the width required

| PRODUCT NO. | DEPTH |
|-------------|-------|
| RL21-__24   | 24"   |
| RL21-__30   | 30"   |

NOTE: Not compatible with weapon storage supports.

**MAGNETIC DIVIDER RL60/RL61**



Front to back

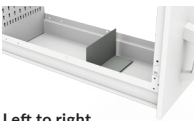

Left to right

- Installs on drawer bottoms and adjustable trays
- Includes a magnetic strip for easy repositioning
- Divider height: 4"
- Color: light gray 071

| PRODUCT NO. | DEPTH             |
|-------------|-------------------|
| RL60-2404   | 24" front to back |
| RL60-3004   | 30" front to back |
| RL61-__04   | Left to right     |

NOTES: Complete the RL61 number with the drawer or the tray width: 05", 06", 07", 08", 09", 10", 11" and 12".  
Not compatible with non-slip drawer/tray liners.  
Not compatible with weapon storage supports.

**NON-SLIP DRAWER / TRAY LINER RL49**

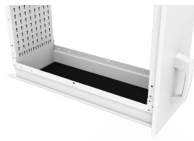

- Protects tools stored in the drawer or on a tray
- Thickness: 1/16"
- Widths available: 05", 06", 07", 08", 09", 10", 11" and 12"
- To order: Specify the width required

| PRODUCT NO. | DEPTH |
|-------------|-------|
| RL49-__24   | 24"   |
| RL49-__30   | 30"   |

NOTE: Not compatible with magnetic dividers.  
Not compatible with weapon storage supports.

**LABEL HOLDER RL81/RL82**



- For 7/8"H paper labels
- Label holder height: 15/16"
- Widths available: 06" and 09"
- To order: Specify the width required

| PRODUCT NO. | TYPE          |
|-------------|---------------|
| RL81-__     | Self-adhesive |
| RL82-__     | Magnetic      |

NOTE: Refer to technical guide R68 for details on accessories compatibility.



# COMPLEMENTARY IMAGES

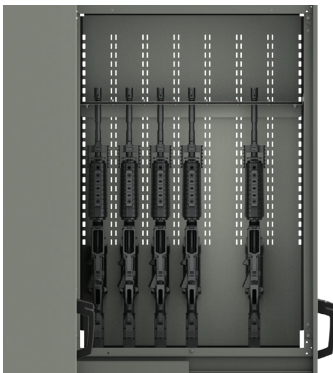
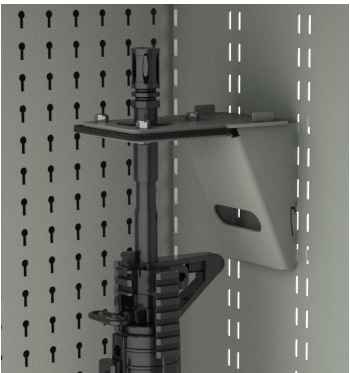
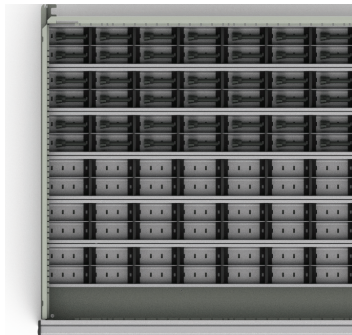
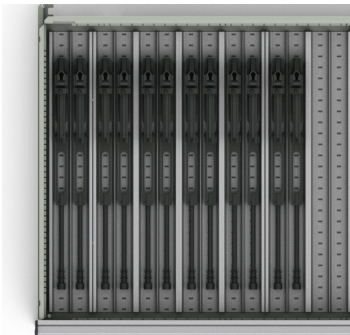
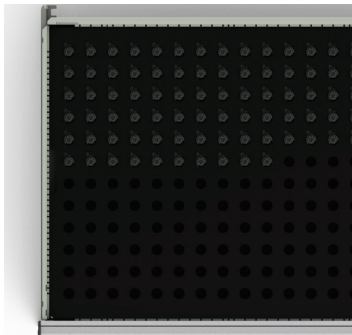
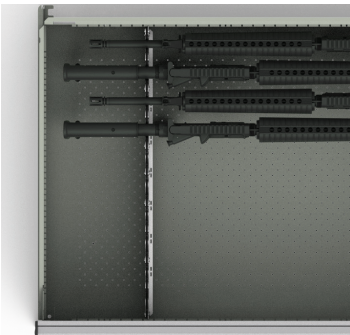



## ROUSSEAU METAL INC.

### INTRODUCTION

Rousseau designs and manufactures shelving, drawer and workstation systems for professional use. Known for their industry-leading durability, quality and innovations, our products are sold through a network of specialized partners who work in a wide range of sectors.

The Rousseau difference is: Flexible and customized solutions, modular and scalable design, unrivaled quality and durability. And above all, it means choosing a manufacturer and distribution partners who always put customers first.

### QUICK ACCESS

Scan the QR codes to visit our different platforms.



**WEBSITE**  
rousseau.com



**CONFIGURATOR**  
MyModel-r.com



**VIDEOS**  
youtube.com



**DISTRIBUTORS ACCESS**  
e-rousseau.com

For more information, please contact your local distributor:



## ROUSSEAU METAL INC.

105, avenue de Gaspé Ouest  
Saint-Jean-Port-Joli (Québec)  
GOR 3G0 CANADA

**DISTRIBUTORS**  
1.800.463.4271

**END USERS**  
1.866.463.4270

**EMAIL**  
info@rousseau.com

**WEBSITE**  
rousseau.com

**DISTRIBUTORS ACCESS**  
e-rousseau.com

**CONFIGURATOR**  
MyModel-r.com



Printed in Canada

## COLORS

### STANDARD COLORS

The colors may differ slightly from those illustrated.

|                              |                                  |                                    |                             |                                    |                                 |                             |                             |
|------------------------------|----------------------------------|------------------------------------|-----------------------------|------------------------------------|---------------------------------|-----------------------------|-----------------------------|
|                              |                                  |                                    |                             |                                    |                                 |                             |                             |
| Avalanche Blue<br><b>055</b> | Everest Blue<br><b>051</b>       | Classic Blue<br><b>052</b>         | Midnight Blue<br><b>057</b> | Glossy Sapphire Blue<br><b>560</b> | Glossy EverGreen<br><b>1025</b> | Black<br><b>091</b>         | Beige<br><b>041</b>         |
|                              |                                  |                                    |                             |                                    |                                 |                             |                             |
| Frost White<br><b>061</b>    | Light Gray<br><b>071</b>         | Modern Gray<br><b>745</b>          | Charcoal Gray<br><b>072</b> | Glossy Carbon Black<br><b>741</b>  | White<br><b>616</b>             | Sienna Orange<br><b>085</b> | Glossy Yellow<br><b>208</b> |
|                              |                                  |                                    |                             |                                    |                                 |                             |                             |
| Flame Red<br><b>081</b>      | Glossy Carmine Red<br><b>806</b> | Glossy Cranberry Red<br><b>815</b> | Glossy Black<br><b>902</b>  |                                    |                                 |                             |                             |

### HANDLE END CAPS

|                          |                     |                      |
|--------------------------|---------------------|----------------------|
|                          |                     |                      |
| Ocean Blue<br><b>011</b> | Black<br><b>031</b> | Orange<br><b>021</b> |

Rousseau is continuously improving its products and reserves the right to make any modifications judged necessary.

7P107A00  
107-MA26A